

Edda

SITS



Edda

M. Jötter *N. Kayser*

designed by: Böttcher & Kayser



UPHOLSTERY



fabric

COMFORTS



standard



lux

COVERS



loose with
velcro

SPECIAL



modular
system

All elements are freestanding.

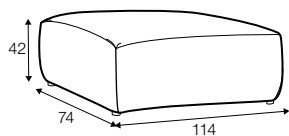

footstool 114x74

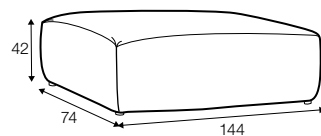

footstool 144x74

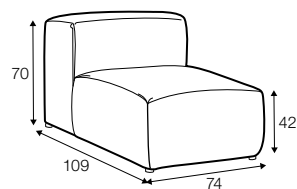

element 74x109

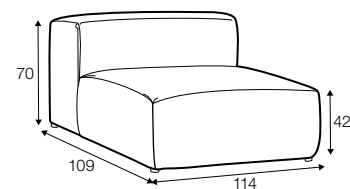

element 114x109

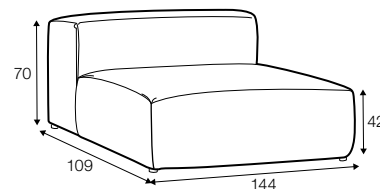

element 144x109

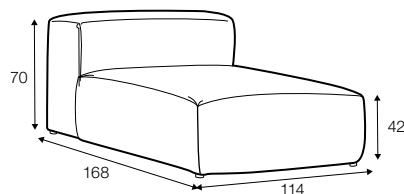

element 114x168

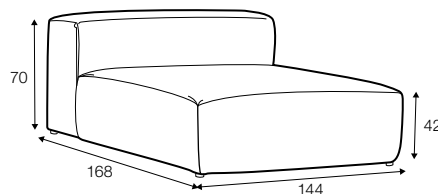

element 144x168

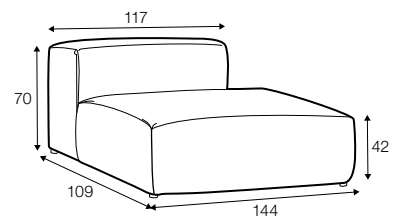

bench 144x109 right / or left

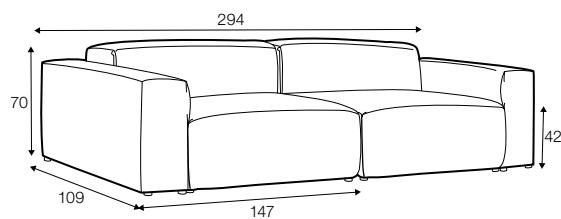

set 1

2x element 114x109 + 2x armrest 109x33

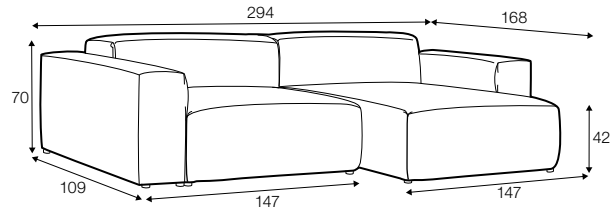

set 2

element 114x109 + element 114x168 + 2x armrest 109x33

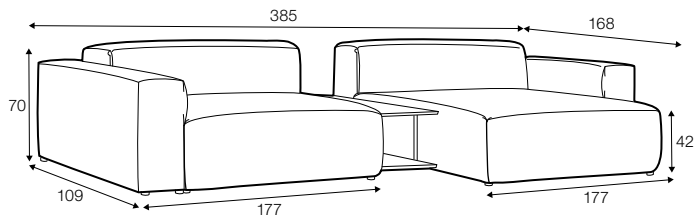

set 3

element 144x109 + element 144x168
 + 2x armrest 109x33 + coffee table 104x31

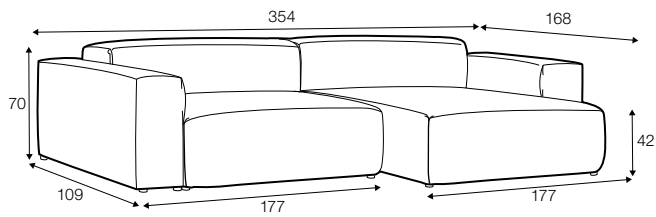

set 4

element 144x109 + element 144x168 + 2x armrest 109x33

extra dimensions

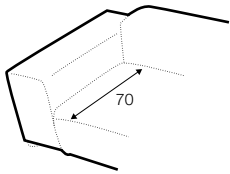

depth of seat

accessories

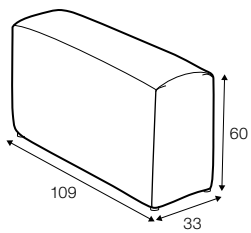

armrest 109x33

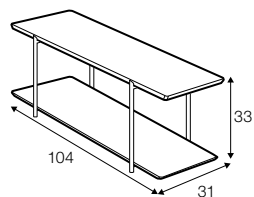

coffee table 104x31

legs

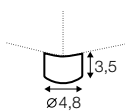

no. 173
 wood

available materials for top



wood: oak



wood: black

available materials for frame



metal: black

profile

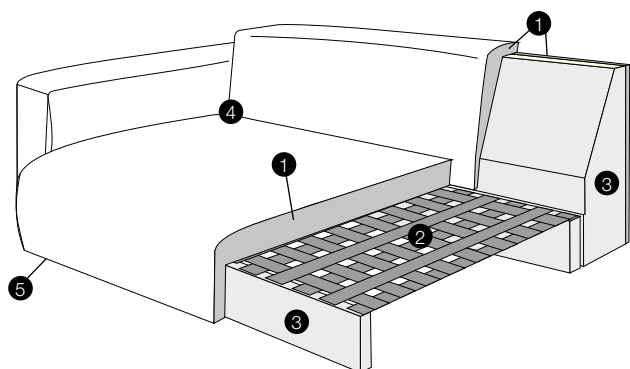

standard

1. polyurethane foam/high resilient polyurethane foam
2. upholstery belts
3. FSC® certified solid wood and wood based elements
4. fabric
5. FSC® certified solid wood or metal legs

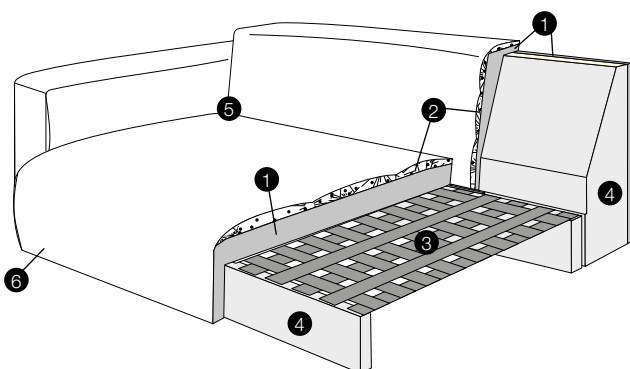

lux

1. polyurethane foam/high resilient polyurethane foam
2. cushion chamber with mix of feather and silicone balls
3. upholstery belts
4. FSC® certified solid wood and wood based elements
5. fabric
6. FSC® certified solid wood or metal legs